

A performance study of Quantum ESPRESSO's PWscf code on multi-core and GPU systems

Josh Romero, Everett Phillips, Gregory Ruetsch, Massimiliano Fatica - NVIDIA
Filippo Spiga - University of Cambridge (UK)
Paolo Giannozzi - University of Udine (IT)

Outline

- Quantum ESPRESSO/PWscf
- GPU implementation in CUDA Fortran
- Benchmarking and Results
- Conclusions

Quantum ESPRESSO/PWscf

Quantum ESPRESSO (QE)

- Integrated suite of open-source software for simulations of materials based on density-functional theory
- Complete distribution contains approximately 520,000 lines of Fortran 95 source code
- Popular package widely used within academia and industry

Plane-Wave Self-Consistent Field (PWscf)

- One of the main programs distributed with QE
- Computes the Kohn-Sham (KS) orbitals and energies of material systems
- Uses an iterative method that seeks self-consistent input and output charge densities
- See *Giannozzi et al. J. Phys 2009 Appendix A.2* for details

Plane-Wave Self-Consistent Field (PWscf)

- Each iteration requires:
 - Diagonalization of the Hamiltonian operator H_{KS}
 - done iteratively using a block Davidson method
 - performed for each KS orbital (**k-point**) across *bands*
 - Computation of output charge density using diagonalization results
- Repeated until self-consistency is obtained within a desired tolerance

Parallelization Options

- PWscf has a number of parallelization options available. Options used in this study:
 - *k*-point parallelization using `-npool`:
 - Distributes *k*-points into N_k pools of processes.
 - Enables parallel execution of the iterative diagonalizations.
 - Linear algebra parallelization using `-ndiag`:
 - Distributes the dense diagonalization, needed by the block Davidson algorithm, among N_D processes.
 - Enables use of distributed eigensolver like ScaLAPACK

GPU Implementation in CUDA Fortran

CUDA Fortran

- Since baseline CPU code is written in Fortran, natural choice for GPU port is CUDA Fortran.
- *CUDA Fortran for Scientists and Engineers* by Ruetsch and Fatica is a good starting reference.
- Requires PGI compilers, free community editions now available at www.pgroup.com

CUDA Fortran

- Benefits:
 - More control than OpenACC:
 - Explicit GPU kernels written natively in Fortran are supported
 - Full control of host/device data movement
 - Directive-based programming available via CUF kernels
 - Easier to maintain than mixed CUDA C and Fortran approaches

Profiling with NVPFROF + NVVP + NVTX

- When porting programs, profiling (and profiling often) is very important:
 - Identify and focus efforts on performance-critical sections of the program
 - Understand interactions between CPU and GPU:
 - Am I getting expected H2D/D2H BW over PCIe or NVLink?
 - Can I hide this data movement behind GPU computation?
 - Understand library behavior:
 - How is my linked MPI library handling communication between GPUs?
 - Is the CPU being used in any library computations?

Profiling with NVPROF + NVVP + NVTX

- NVPROF:
 - Powerful profiler provided in every CUDA toolkit installation
 - Can be used to gather detailed kernel properties and timing information
- NVIDIA Visual Profiler (NVVP):
 - Graphical interface to visualize and analyze NVPROF generated profiles
 - Does not show CPU activity out of the box
- NVIDIA Tools EXTension (NVTX) markers:
 - Enables annotation with labeled ranges within program
 - Useful for categorizing parts of profile to put activity into context
 - Can be used to visualize normally hidden CPU activity (e.g. MPI communication)

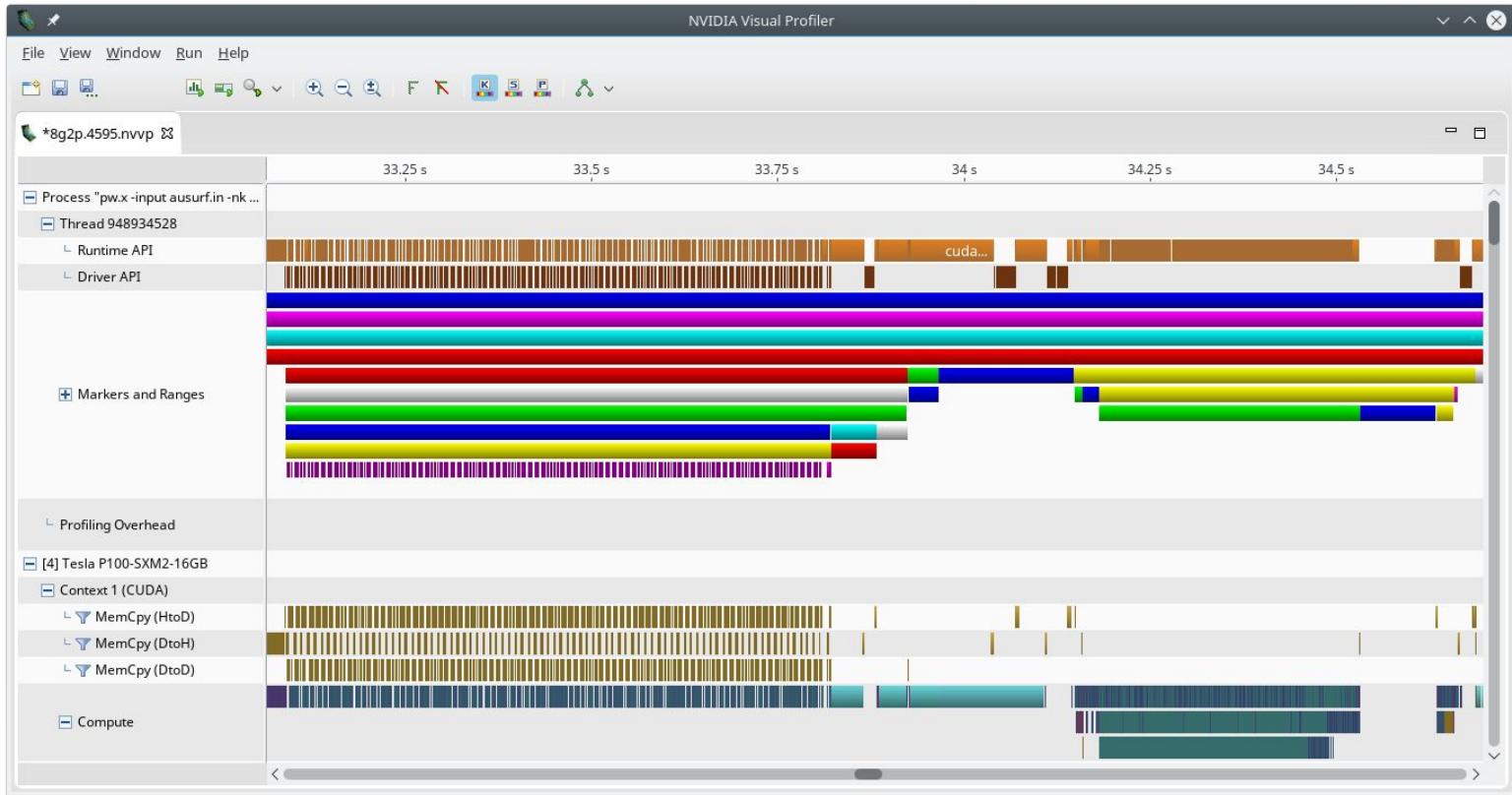

Sample NVVP segment from AUSURF112 on
NVIDIA DGX-1 System

GPU Porting of Key Computational Routines

- The iterative diagonalization and computation of charge density are dominated by three basic operation types:
 - Level-3 BLAS routines, predominantly Z / DGEMM
 - 3D Fast Fourier Transforms (FFT), typically distributed
 - dense-matrix diagonalization via LAPACK or ScaLAPACK
- BLAS routines easily ported using available routines in CUBLAS library
- 3D FFT and dense-matrix diagonalization more involved
- Remaining routines ported to GPU as necessary for performance or to remove redundant host/device data movement

3D Fast Fourier Transforms

- Required in iterative diagonalization and charge computation
- Component 1D FFT computations computed using CUFFT
- Generally distributed among the processes in each k -point pool:
 - requires transposition and data communication across processes using `MPI_Alltoall` or similar communication pattern
 - Many 3D FFT computations for each k -point, one for each band index

3D Fast Fourier Transforms

- Existing CPU implementation not amenable to a performant GPU port:
 - Individual FFTs for each band too small to saturate GPU resources
 - No attempt to overlap FFT computation with MPI communication:
 - problematic on GPU systems in cases where communication buffers must be staged through the host
- To address these issues, implemented a batched FFT strategy where multiple band FFTs computed together
 - More available concurrent work for better GPU utilization
 - Provides straightforward mechanism for pipelining data movement and computation
 - Requires more memory, but this was not an issue in tested cases

3D Fast Fourier Transforms

- As a further optimization, implemented all-to-all communication using non-blocking `MPI_Isend/MPI_Irecv`
 - Important on systems which are capable of multiple concurrent peer-to-peer (P2P) transfers between GPUs
- A number of MPI distributions we tried showed suboptimal utilization of available P2P bandwidth on systems with multiple P2P connections
 - For all-to-all, implemented explicit handling of P2P communication using CUDA interprocess communication (IPC), with non-peer transfers handled by linked MPI library

Diagonalization

- The dense-matrix diagonalization, used for the block Davidson method, is another computationally expensive routine.
- Consists of computing eigenvalues and eigenvectors of a modest size system ($N \times N$ with $N \sim O(10^3)$) using a dense eigensolver
- On CPU, this operation is typically distributed over N_D processes and computed using ScaLAPACK, or similar library

Diagonalization

- Current GPU port targets serial path ($N_D = 1$) using a custom developed GPU eigensolver
 - one GPU per k-point pool performs the dense-matrix diagonalization
- Custom solver used in lieu of several existing options for GPU, like MAGMA:
 - Written to reduce dependencies on CPU resources for computation, only reduced tridiagonal solve completed on CPU using LAPACK
 - Beneficial on “fat” nodes, with high GPU to CPU socket ratios, where bottlenecks due to limited CPU resources can arise
- See GTC talk for more info on the solver development

Benchmarking and Results

Testing Details

- Performance results for two benchmark cases were obtained on several GPU systems and a reference CPU system.
- On reference CPU system:
 - Distributed ELPA solver used for diagonalization ($N_D > 1$)
 - MKL for other BLAS/LAPACK routines
 - OpenMP enabled, tried many configurations with best cases reported
- On GPU systems:
 - Custom serial eigensolver used for diagonalization ($N_D = 1$)
 - CUBLAS for BLAS routines on GPU, MKL/ESSL for any BLAS/LAPACK CPU routines
 - GDR features tested on systems with P2P connectivity (CUDA-aware MPI + custom IPC)
 - OpenMP enabled on Intel-based systems
 - OpenMP disabled on IBM system in favor of using multithreaded ESSL

Wilkes-2
(Cambridge)

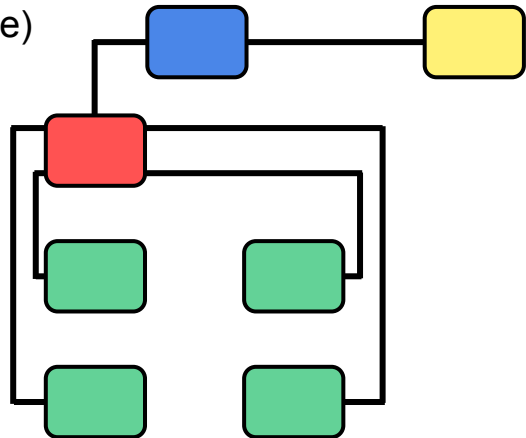

NVIDIA DGX-1

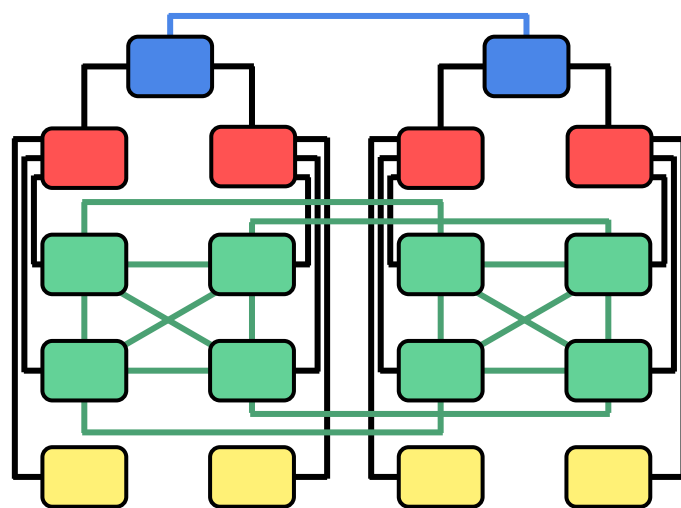

Piz Daint
(CSCS)

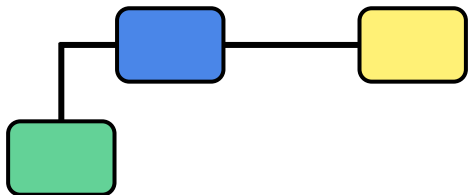

Summit Dev
(ORNL)

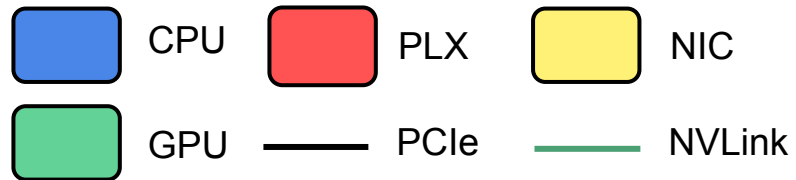
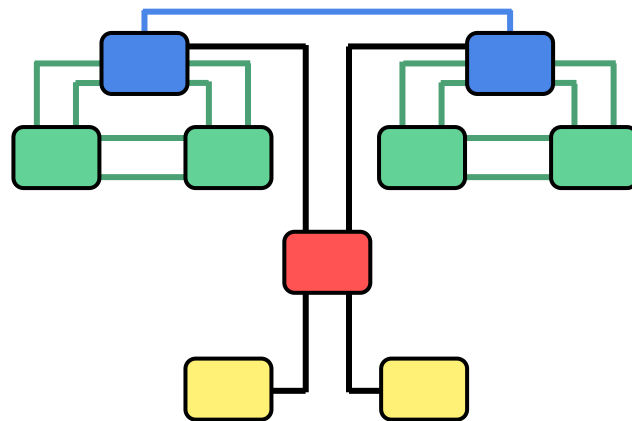

Benchmark Cases

- AUSURF112:
 - Gold surface with 112 atoms and 2 k -points
 - Smaller case suitable for workstations and small distributed systems
- Ta2O5:
 - Tantalum pentoxide with 96 atoms and 26 k -points.
 - Larger case suitable for scaling from small to large distributed systems

Parameter	Benchmark case	
	AUSURF112	Ta2O5
Number of atomic species	1	2
Number of atoms	112	96
Number of electrons	1,232	544
Number of Kohn-Sham states	739	326
Number of k -points	2	26
Number of plane waves	100,747	477,247
Kinetic energy cutoff	25 Ry	130 Ry
Charge density cutoff	200 Ry	520 Ry
Dimension of dense FFT grid	{180, 90, 288}	{198, 168, 220}

AUSURF112:

PWscf Time

- Factor of 2-3 speedup using GPU relative to CPU system
- Fixing number of resources per pool gives nearly linear scaling with increased resources
- Increasing number of resources per pool less efficient

System	N_K	Number of CPUs or GPUs used				
		2	4	8	16	32
Broadwell (CPU)	1	1142.24	642.03	369.66	272.00	266.20
	2	1190.13	586.84	335.00	196.54	144.07
Piz Daint	1	286.24	219.91	171.80	—	—
	2	—	149.21	115.87	—	—
DGX-1	1	347.82	271.37	210.67	—	—
	2	—	184.10	142.15	—	—
DGX-1, GDR	1	270.21	190.12	174.75	—	—
	2	—	142.43	100.54	—	—
Summit Dev	1	321.69	234.32	187.69	—	—
	2	—	176.50	128.85	—	—
Summit Dev, GDR	1	308.52	227.74	188.39	—	—
	2	—	169.60	124.22	—	—
Wilkes-2	1	395.26	326.71	227.61	—	—
	2	—	226.89	167.80	—	—
Wilkes-2, GDR	1	300.03	226.13	203.59	—	—
	2	—	164.63	116.50	—	—
Workstation	1	334.23	—	—	—	—
Workstation, GDR	1	279.54	—	—	—	—

AUSURF112:

PWscf Time

- Factor of 2-3 speedup using GPU relative to CPU system
- Fixing number of resources per pool gives nearly linear scaling with increased resources
- Increasing number of resources per pool less efficient

System	N_K	Number of CPUs or GPUs used				
		2	4	8	16	32
Broadwell (CPU)	1	1142.24	642.03	369.66	272.00	266.20
	2	1190.13	586.84	335.00	196.54	144.07
Piz Daint	1	286.24	219.91	171.80	—	—
	2	—	149.21	115.87	—	—
DGX-1	1	347.82	271.37	210.67	—	—
	2	—	184.10	142.15	—	—
DGX-1, GDR	1	270.21	190.12	174.75	—	—
	2	—	142.43	100.54	—	—
Summit Dev	1	321.69	234.32	187.69	—	—
	2	—	176.50	128.85	—	—
Summit Dev, GDR	1	308.52	227.74	188.39	—	—
	2	—	169.60	124.22	—	—
Wilkes-2	1	395.26	326.71	227.61	—	—
	2	—	226.89	167.80	—	—
Wilkes-2, GDR	1	300.03	226.13	203.59	—	—
	2	—	164.63	116.50	—	—
Workstation	1	334.23	—	—	—	—
Workstation, GDR	1	279.54	—	—	—	—

AUSURF112:

PWscf Time

- Factor of 2-3 speedup using GPU relative to CPU system
- Fixing number of resources per pool gives nearly linear scaling with increased resources
- Increasing number of resources per pool less efficient

System	N_K	Number of CPUs or GPUs used				
		2	4	8	16	32
Broadwell (CPU)	1	1142.24	642.03	369.66	272.00	266.20
	2	1190.13	586.84	335.00	196.54	→ 144.07
Piz Daint	1	286.24	219.91	171.80	—	—
	2	—	149.21	→ 115.87	—	—
DGX-1	1	347.82	271.37	210.67	—	—
	2	—	184.10	142.15	—	—
DGX-1, GDR	1	270.21	190.12	174.75	—	—
	2	—	142.43	→ 100.54	—	—
Summit Dev	1	321.69	234.32	187.69	—	—
	2	—	176.50	128.85	—	—
Summit Dev, GDR	1	308.52	227.74	188.39	—	—
	2	—	169.60	→ 124.22	—	—
Wilkes-2	1	395.26	326.71	227.61	—	—
	2	—	226.89	167.80	—	—
Wilkes-2, GDR	1	300.03	226.13	203.59	—	—
	2	—	164.63	→ 116.50	—	—
Workstation	1	334.23	—	—	—	—
Workstation, GDR	1	279.54	—	—	—	—

AUSURF112: 8 GPU/CPU

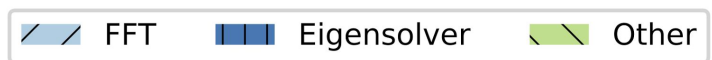

- GPU vs. CPU systems:
 - Faster performance on GPU systems
 - GPU eigensolver outperforming ELPA
- GPU systems:
 - FFT performance improvement with GDR
 - Eigensolver on Summit Dev slower than on Intel systems, more consistent across Intel systems

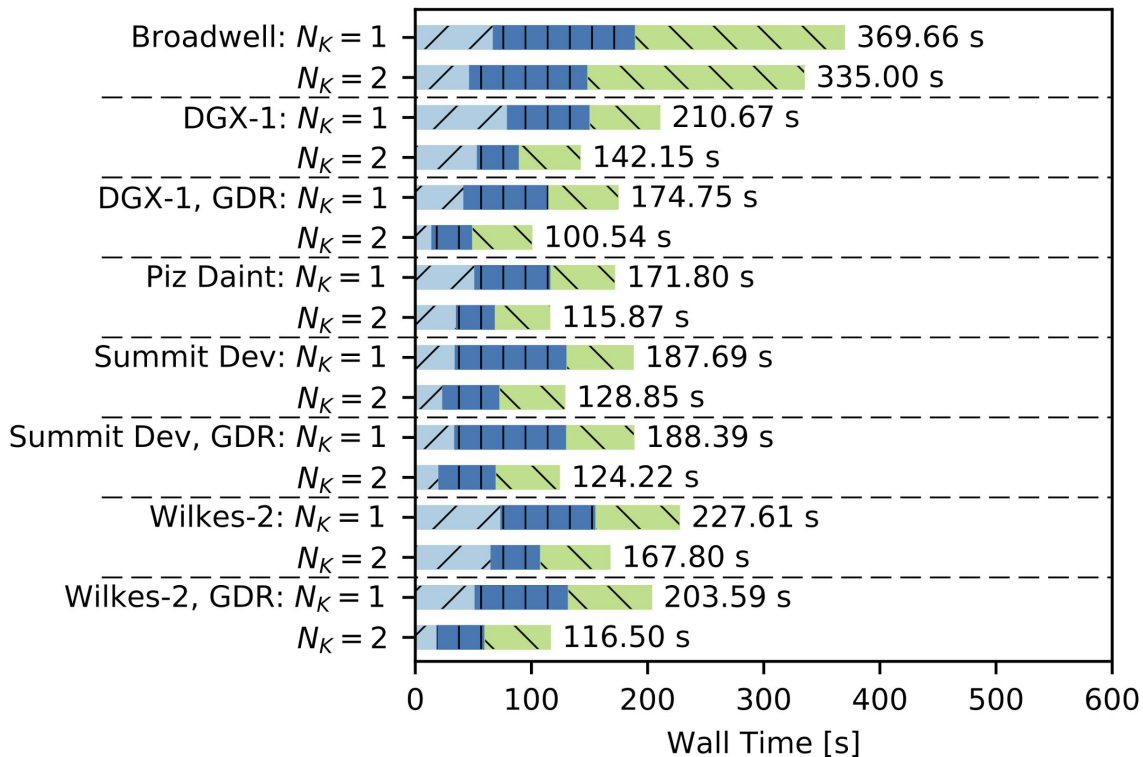

AUSURF112: 8 GPU/CPU

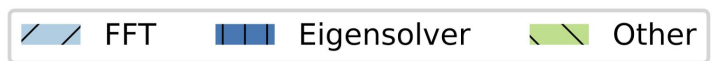

- GPU vs. CPU systems:
 - Faster performance on GPU systems
 - GPU eigensolver outperforming ELPA
- GPU systems:
 - FFT performance improvement with GDR
 - Eigensolver on Summit Dev slower than on Intel systems, more consistent across Intel systems

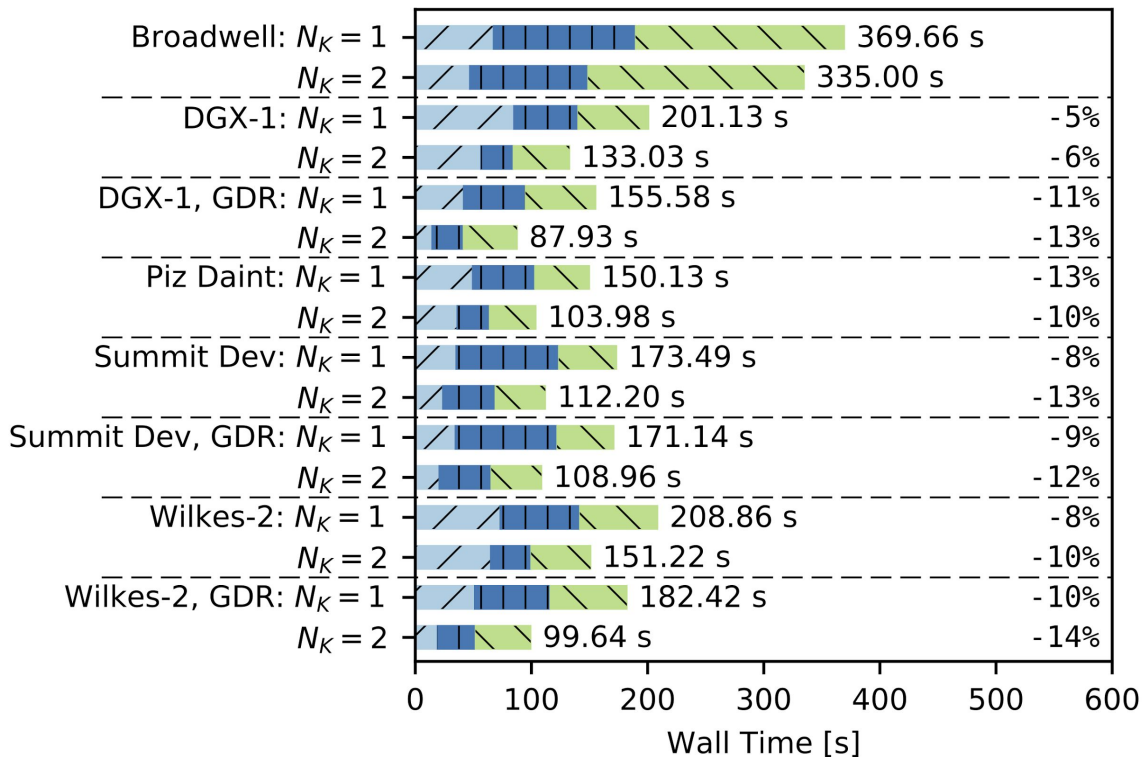

Ta2O5: PWscf Time

- Similar performance trends to AUSURF112 case
- Larger number of available k -points allows for scaling out further

System	N_K	Number of CPUs or GPUs used				
		8	26	52	104	208
Broadwell (CPU)	13	—	—	1374.26	809.36	540.64
	26	—	3055.46	1566.95	682.05	378.73
Piz Daint	1	5273.93	—	—	—	—
	2	3602.07	—	—	—	—
	13	—	—	617.58	419.39	330.85
	26	—	—	—	315.60	217.29
DGX-1	1	7253.06	—	—	—	—
	2	5008.94	—	—	—	—
DGX-1, GDR	1	4139.18	—	—	—	—
	2	2701.00	—	—	—	—
Summit Dev	1	4122.03	—	—	—	—
	2	3236.12	—	—	—	—
	13	—	—	581.15	394.62	289.30
	26	—	—	—	305.66	216.95
Summit Dev, GDR	1	3994.21	—	—	—	—
	2	2959.70	—	—	—	—
	13	—	—	544.83	398.91	292.87
	26	—	—	—	284.90	207.37
Wilkes-2	1	7394.40	—	—	—	—
	2	6103.55	—	—	—	—
	13	—	—	1035.20	656.85	—
	26	—	—	—	515.78	—
Wilkes-2, GDR	1	5032.00	—	—	—	—
	2	3264.26	—	—	—	—
	13	—	—	572.43	460.16	—
	26	—	—	—	273.86	—

Ta2O5: PWscf Time

- Similar performance trends to AUSURF112 case
- Larger number of available k -points allows for scaling out further

System	N_K	Number of CPUs or GPUs used				
		8	26	52	104	208
Broadwell (CPU)	13	—	—	1374.26	809.36	540.64
	26	—	3055.46	1566.95	682.05	378.73
Piz Daint	1	5273.93	—	—	—	—
	2	3602.07	—	—	—	—
	13	—	—	617.58	419.39	330.85
	26	—	—	—	315.60	217.29
DGX-1	1	7253.06	—	—	—	—
	2	5008.94	—	—	—	—
DGX-1, GDR	1	4139.18	—	—	—	—
	2	2701.00	—	—	—	—
Summit Dev	1	4122.03	—	—	—	—
	2	3236.12	—	—	—	—
	13	—	—	581.15	394.62	289.30
	26	—	—	—	305.66	216.95
Summit Dev, GDR	1	3994.21	—	—	—	—
	2	2959.70	—	—	—	—
	13	—	—	544.83	398.91	292.87
	26	—	—	—	284.90	207.37
Wilkes-2	1	7394.40	—	—	—	—
	2	6103.55	—	—	—	—
	13	—	—	1035.20	656.85	—
	26	—	—	—	515.78	—
Wilkes-2, GDR	1	5032.00	—	—	—	—
	2	3264.26	—	—	—	—
	13	—	—	572.43	460.16	—
	26	—	—	—	—	273.86

Ta2O5: PWscf Time

- Similar performance trends to AUSURF112 case
- Larger number of available k -points allows for scaling out further

System	N_K	Number of CPUs or GPUs used				
		8	26	52	104	208
Broadwell (CPU)	13	—	—	1374.26	809.36	540.64
	26	—	3055.46	1566.95	682.05	378.73
Piz Daint	1	5273.93	—	—	—	—
	2	3602.07	—	—	—	—
	13	—	—	617.58	419.39	330.85
	26	—	—	—	315.60	217.29
DGX-1	1	7253.06	—	—	—	—
	2	5008.94	—	—	—	—
DGX-1, GDR	1	4139.18	—	—	—	—
	2	2701.00	—	—	—	—
Summit Dev	1	4122.03	—	—	—	—
	2	3236.12	—	—	—	—
	13	—	—	581.15	394.62	289.30
	26	—	—	—	305.66	216.95
Summit Dev, GDR	1	3994.21	—	—	—	—
	2	2959.70	—	—	—	—
	13	—	—	544.83	398.91	292.87
	26	—	—	—	284.90	207.37
Wilkes-2	1	7394.40	—	—	—	—
	2	6103.55	—	—	—	—
	13	—	—	1035.20	656.85	—
	26	—	—	—	515.78	—
Wilkes-2, GDR	1	5032.00	—	—	—	—
	2	3264.26	—	—	—	—
	13	—	—	572.43	460.16	—
	26	—	—	—	273.86	—

Ta2O5: 104 GPU/CPU

- GPU vs. CPU systems:
 - ELPA faster in this case, but GPU eigensolver remains competitive
- GPU systems:
 - On fat systems, GDR required for high FFT performance
 - Summit Dev has high FFT performance without GDR due to host-device NVLink

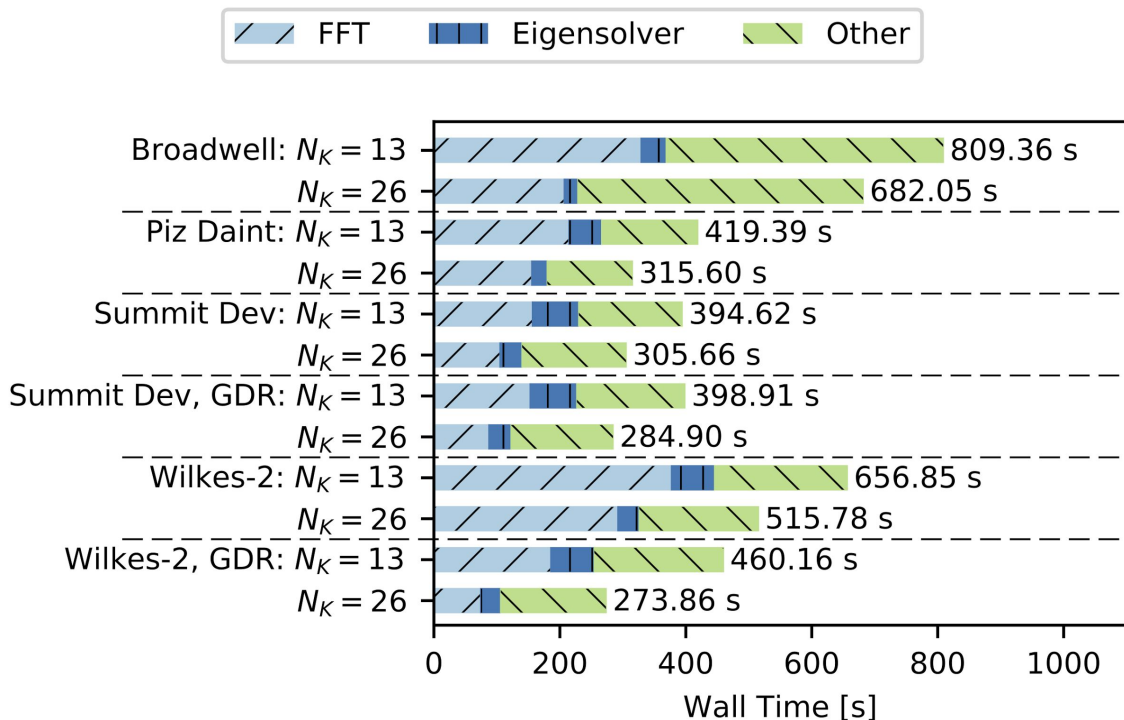

Ta2O5: 104 GPU/CPU

- GPU vs. CPU systems:
 - ELPA faster in this case, but GPU eigensolver remains competitive
- GPU systems:
 - On fat systems, GDR required for high FFT performance
 - Summit Dev has high FFT performance without GDR due to host-device NVLink

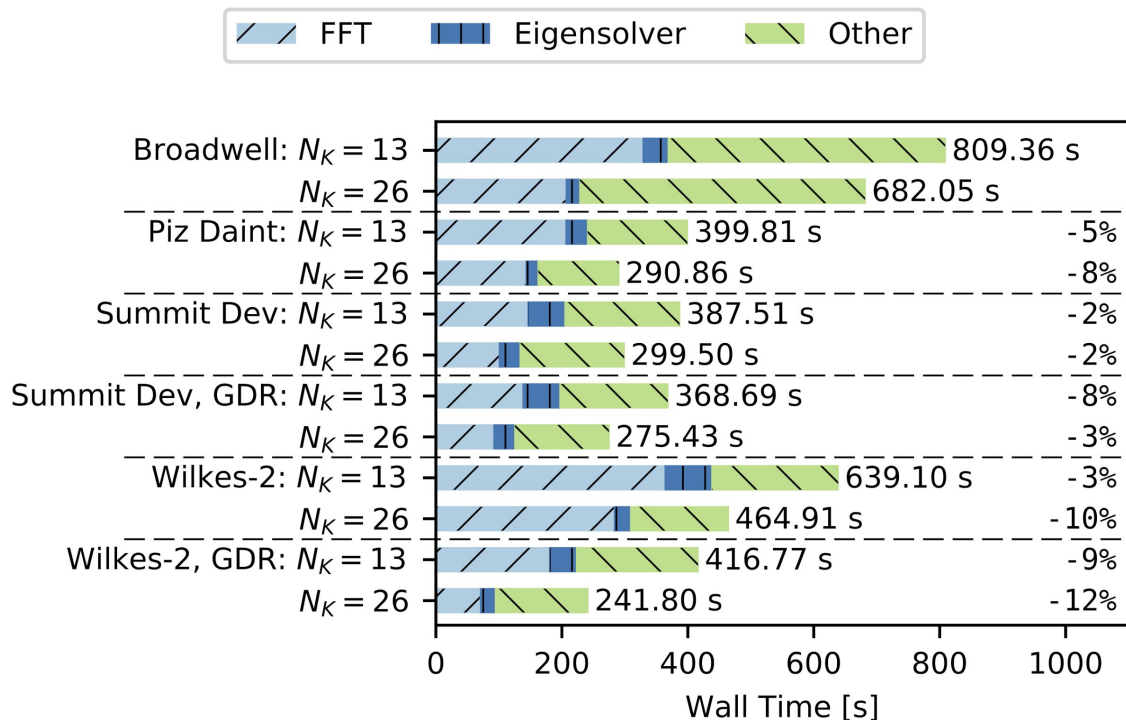

Ta2O5: 104 GPU/CPU

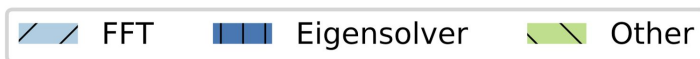

- GPU vs. CPU systems:
 - ELPA faster in this case, but GPU eigensolver remains competitive
- GPU systems:
 - On fat systems, GDR required for high FFT performance
 - Summit Dev has high FFT performance without GDR due to host-device NVLink

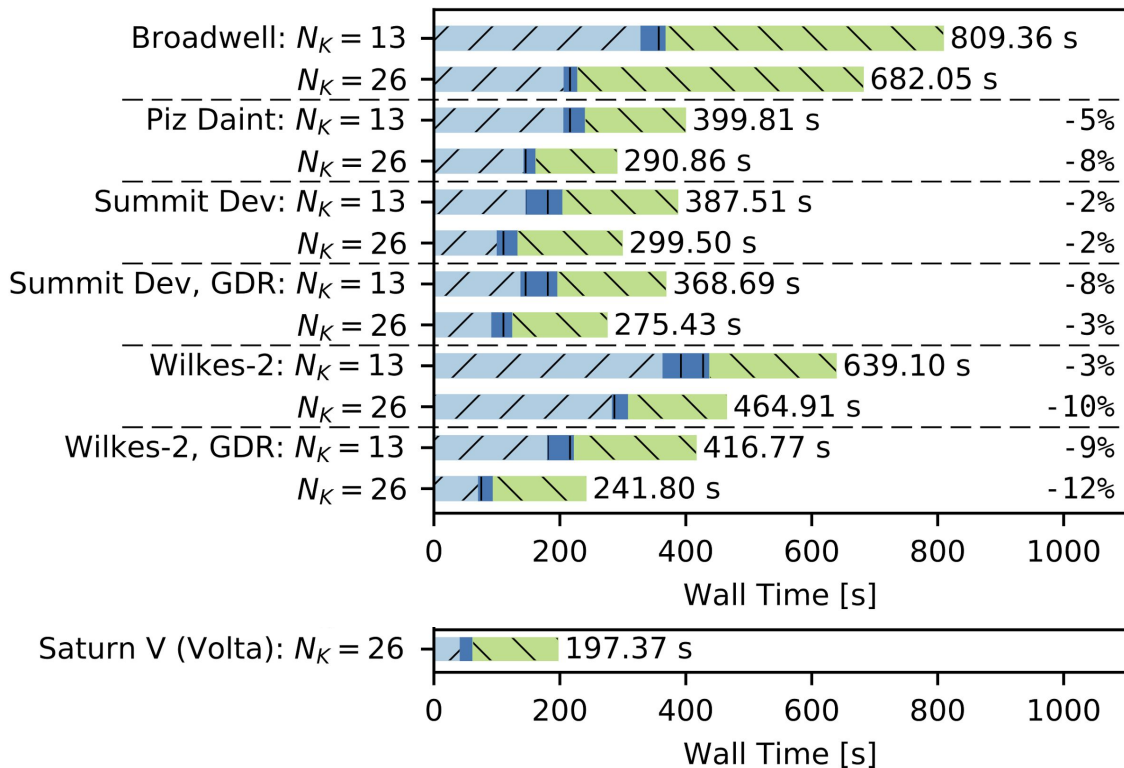

Updated results using V1.0

Si63Ge (vc-relax)

	QE-GPU CSCS		QE CSCS	QE Cineca	
	1 P100	10 P100	20 BW (360c)	1 KNL (60c)	10 KNL (640c)
npool	1	10	10	5	10
init_run	15.92s	7.50s	4.45s	21.61s	10.33s
electrons	668.06s	108.78s	235.58s	1542.72s	292.86s
update_pot	1.37s	1.04s	10.42s	31.95s	7.94s
forces	12.06s	3.03s	13.20s	60.91s	11.93s
stress	74.28s	15.82s	75.69s	260.82s	38.55s
cdiaghg	71.38s	6.89s	15.51s	147.97s	76.15s
PWSCF	774.49s	138.70s	342.26s	1934.28s	400.29s

Fermi energy	6.5908 ev	6.5908 ev	6.5908 ev	6.5908 ev	6.5908 ev
Total energy	-813.93522903 Ry	-813.93522903 Ry	-813.93522904 Ry	-813.93522904 Ry	-813.93522903 Ry
Total force	0.002992	0.002992	0.002992	0.002992	0.002992
Total stress	0.00000062	0.00000062	0.00000062	0.00000062	0.00000062
Pressure	0.09	0.09	0.09	0.09	0.09

Conclusions

Conclusions

- New GPU implementation can reduce time to solution by a factor of 2 - 3 relative to the reference CPU system
- Custom serial GPU eigensolver provides competitive performance relative to ScaLAPACK and ELPA with limited sensitivity to host resources. Available on Github at: https://github.com/NVIDIA/Eigensolver_gpu
- Full utilization of P2P resources essential for high performance, especially on systems with large GPU to CPU socket ratios
- CUDA-accelerated version of QE is open-source and available on Github at: <https://github.com/fspiga/qe-gpu>